

merk A  
get: 1x  
gesp: -  
opm: - hardsteen onderdopel  
- deefse deur

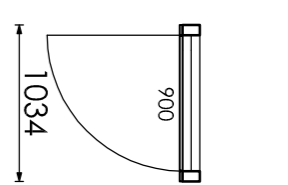

merk B  
get: 1x  
gesp: -  
opm: Deze deur behouden met houten delen gelijk aan de gewelde. Houten onderdopel verdukt achter houden oelen.

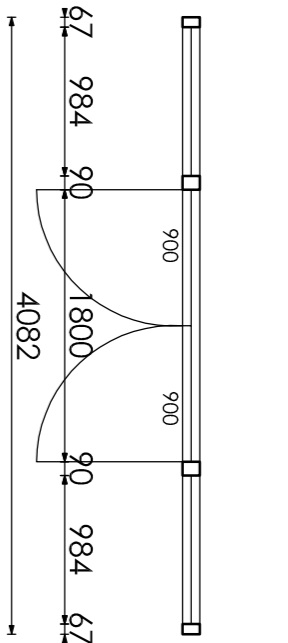

merk C  
get: 1x  
gesp: -  
opm: - hardsteen onderdopel

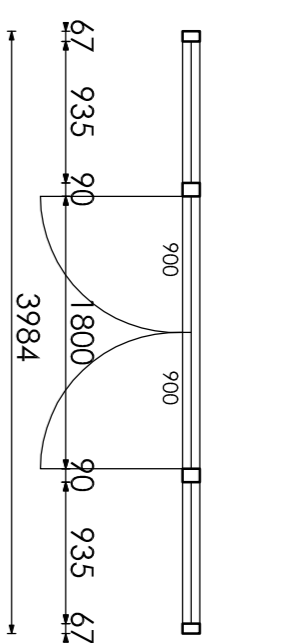

merk D  
get: 1x  
gesp: -  
opm: - hardsteen onderdopel

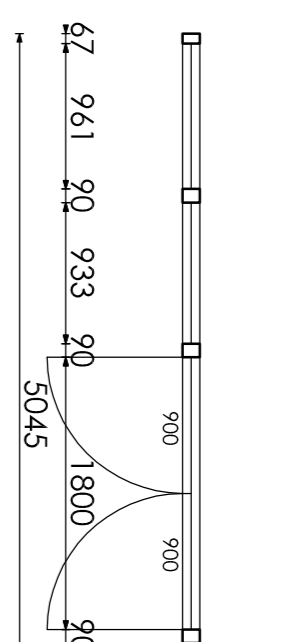

merk E  
get: 1x  
gesp: -  
opm: - hardsteen onderdopel

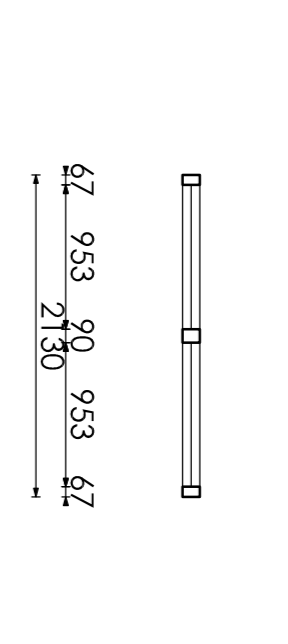

merk F  
get: 1x  
gesp: -  
opm: - hardsteen onderdopel

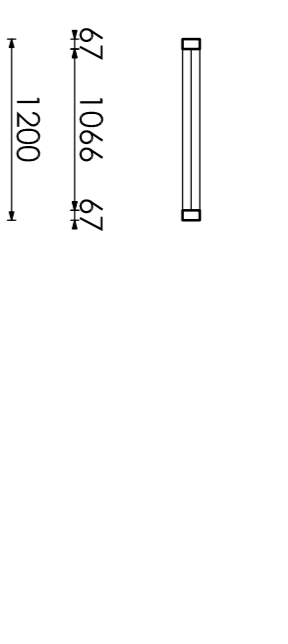

merk G  
get: 2x  
gesp: -  
opm: - hardsteen onderdopel

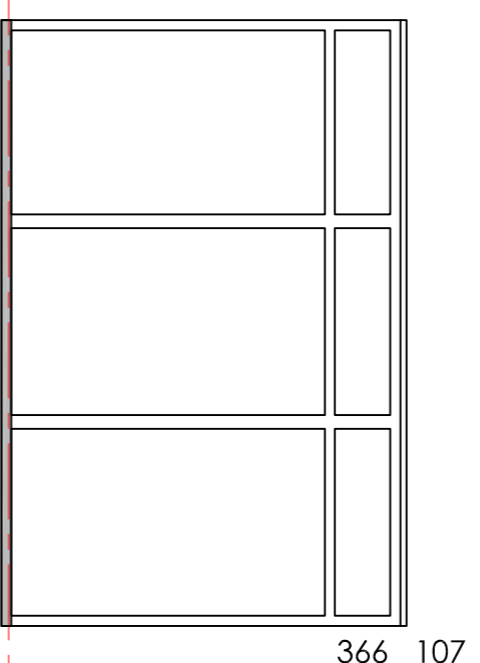

67 1217 90 1237 90 1237 68

merk H

get: 1x  
gesp: -  
opm: - hardsteen onderdopel

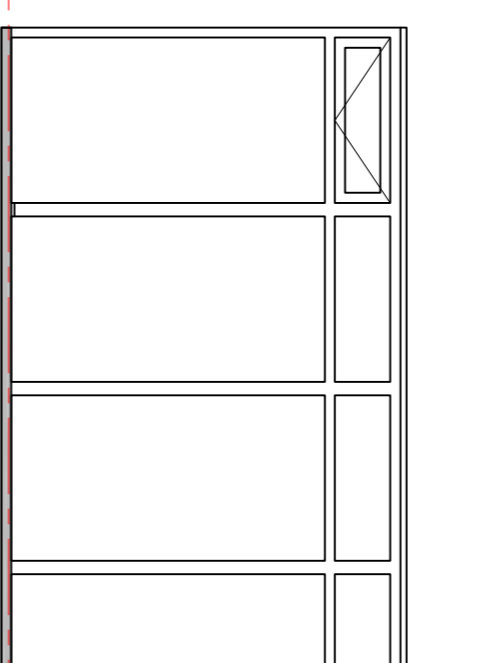

67 1093 90 1093 90 1093 90 1093 90 1073 67

merk I

get: 1x  
gesp: -  
opm: - kogijn voordien van screens

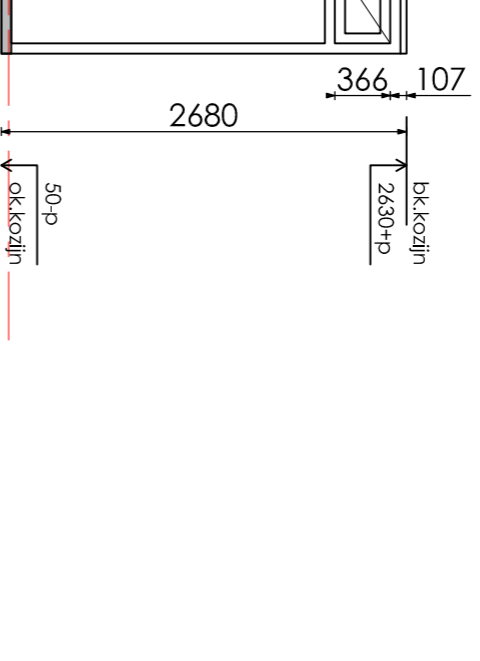

67 1210 0,67

merk J

get: 1x  
gesp: -  
opm: - houten lamellen forme schouderend bovenliggen op kogijn

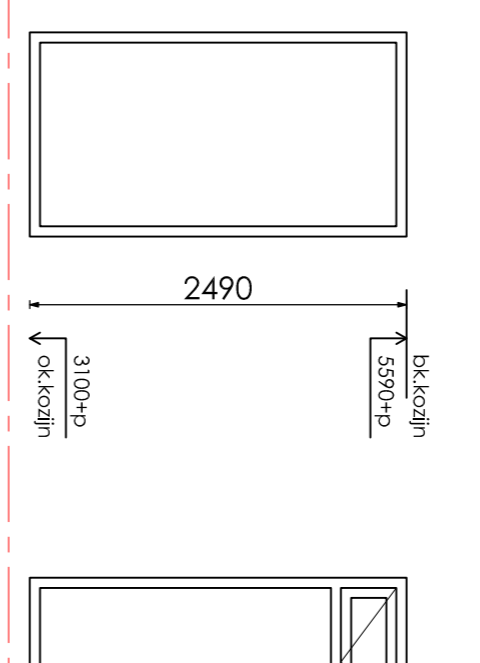

67 980 90 980 67

merk K

get: 1x  
gesp: -  
opm: -

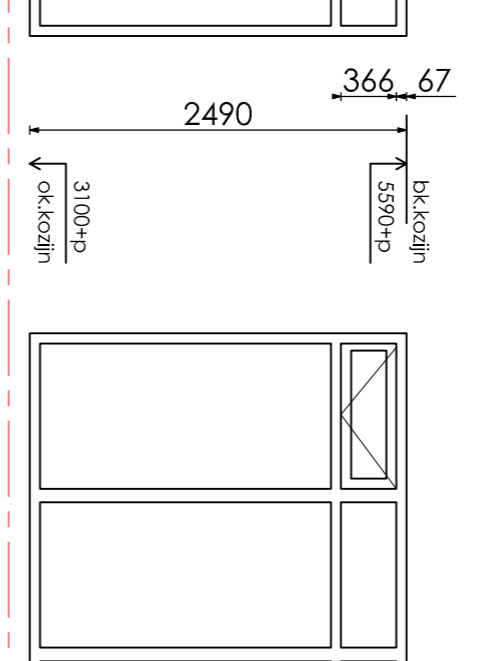

67 961 90 961 90 961 90 961 67

merk L

get: 1x  
gesp: -  
opm: -

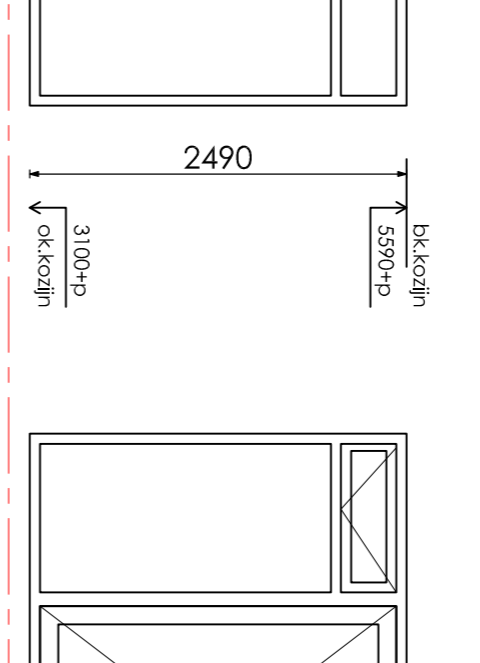

67 984 90 1800 4859 90 1762 67

merk M

get: 1x  
gesp: -  
opm: -

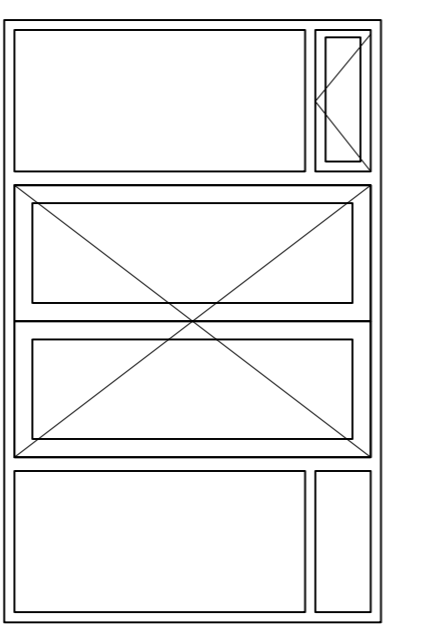

67 935 90 1800 90 935 67

merk N

get: 1x  
gesp: -  
opm: -

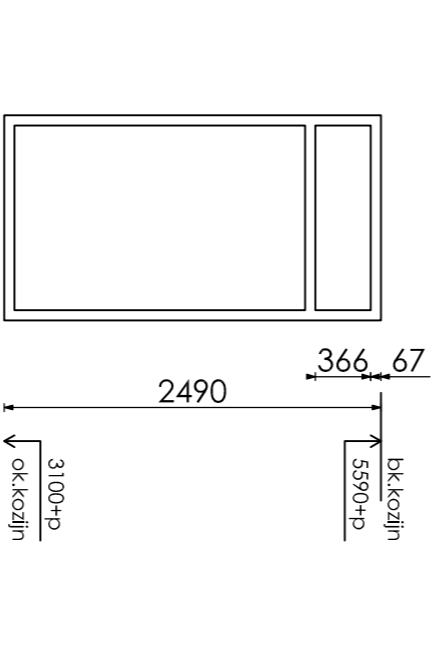

67 1222 67

merk O

get: 1x  
gesp: -  
opm: -

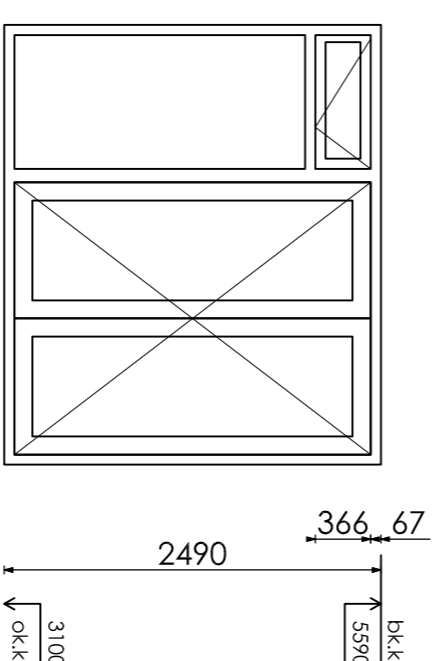

67 885 90 1800 90 2909 67

merk P

get: 1x  
gesp: -  
opm: -

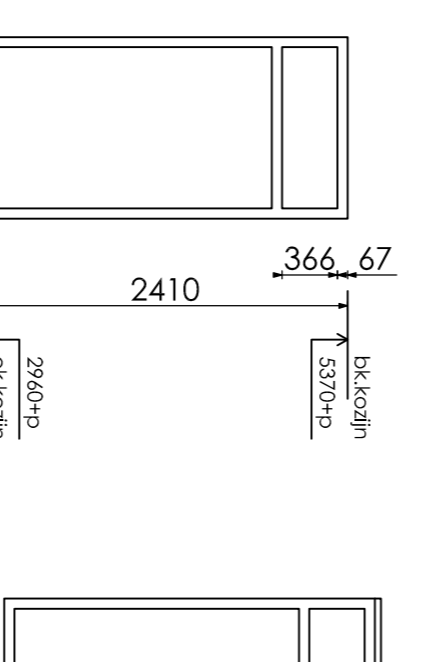

67 1066 67

merk Q

get: 2x  
gesp: -  
opm: -

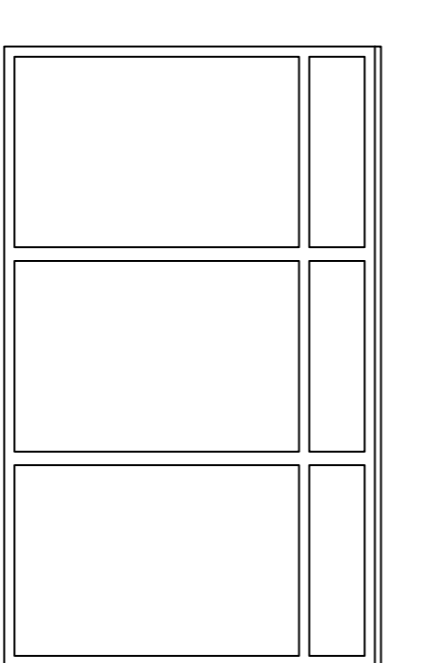

67 1261 90 1261 90 1261 90 1261 67

merk R

get: 1x  
gesp: -  
opm: - kogijn voordien van screens

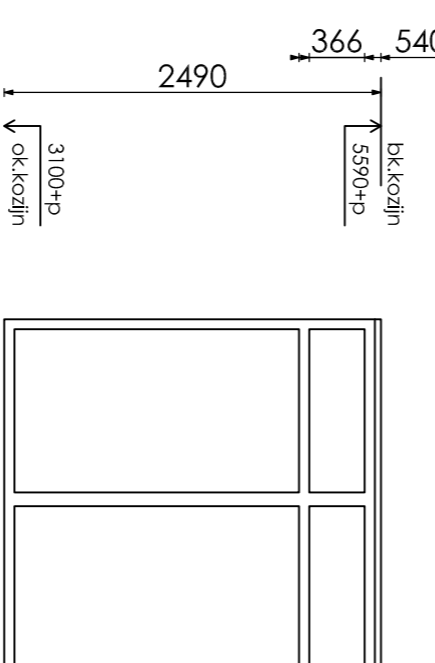

67 1080 90 1080 90 1080 67

merk S

get: 1x  
gesp: -  
opm: - kogijn voordien van screens

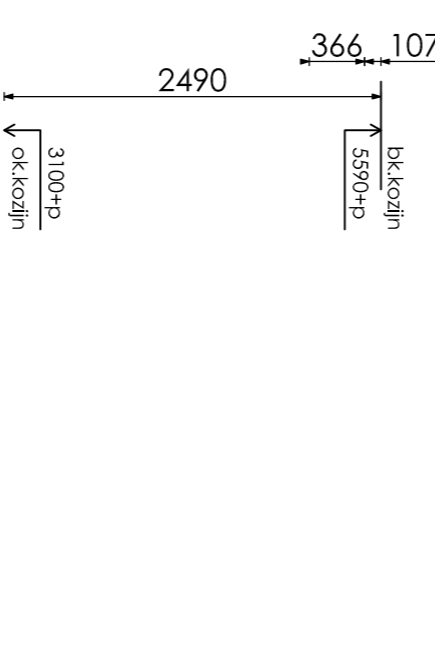

67 1066 67

merk T

get: 1x  
gesp: -  
opm: -

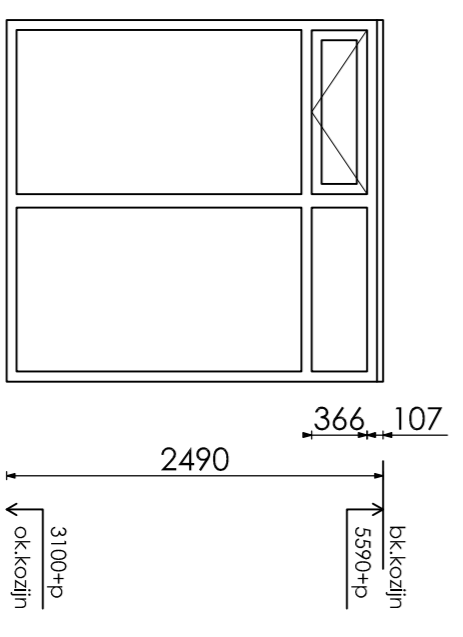

67 1084 90 1084 67

merk U

get: 1x  
gesp: -  
opm: - kogijn voordien van screens

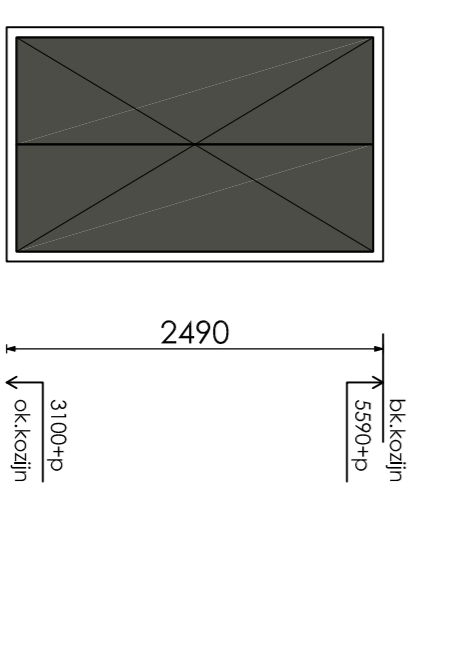

67 1416 67

merk V

get: 1x  
gesp: -  
opm: -

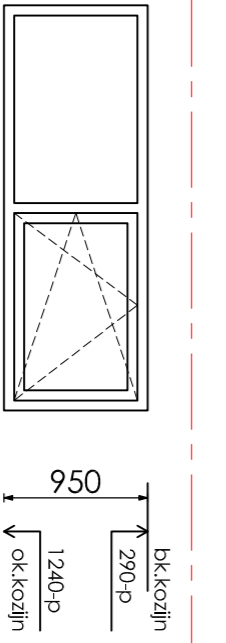

950

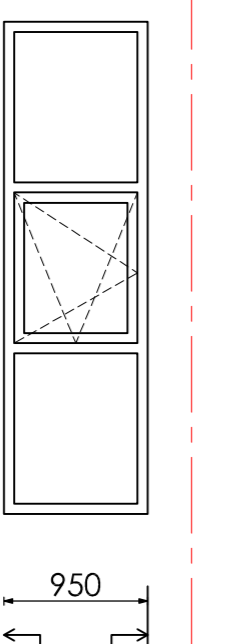

950

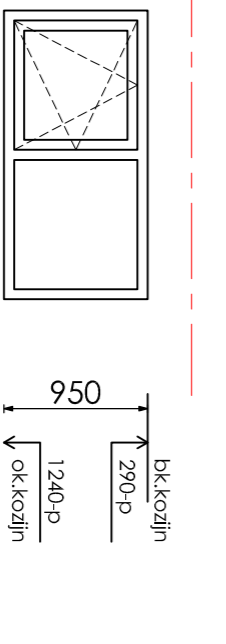

950

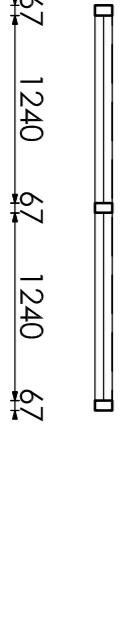

67 1240 67 1240 67

merk W

get: 1x  
gesp: -  
opm: -

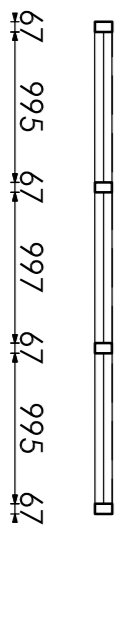

67 995 67 997 67 995 67

merk X

get: 1x  
gesp: -  
opm: -

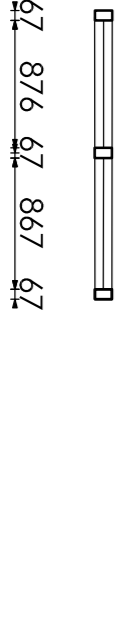

67 876 67 867 67

merk Y

get: 1x  
gesp: -  
opm: -

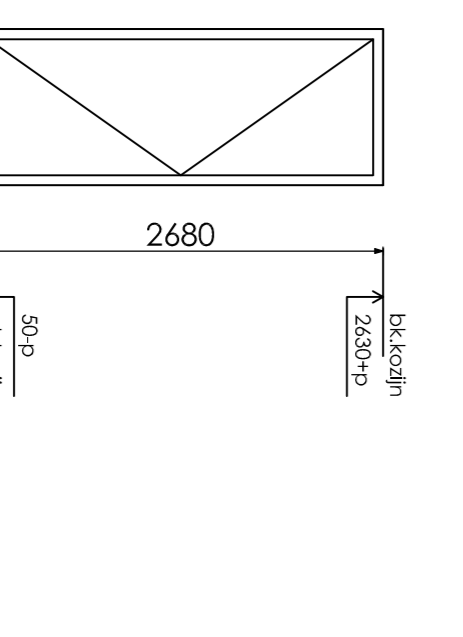

67 1034

merk Z

get: 1x  
gesp: -  
opm: -

100%  
nwpers

schaal: 1:50

datum: 25-06-2012

getekend: J. Ruijs

formaat: A1

opdracht gever:  
Fam. Roodbeem  
Satijnzwam, Veerendaal

project:  
Nieuwbouw woonhuis  
Salamanca, Kavel 9

wijzigingen: c:  
a: 02-07-2012 dt:  
b: 27-08-2012 e:

tekenings:  
Buitenkozijnen  
fase:  
Verstekening

Gen. Urthartdian 43  
6861 GE Ossenseek  
tel. 020 - 840 58 50  
info@100percentnwpers.nl  
www.100percentnwpers.nl

WE-40